



The project "Diagnostics in the high-energy X-ray range" beamline at the Siberian synchrotron SKIF

Dr. KUPER, Konstantin (Budker Institute of Nuclear Physics);
Budker Institute of Nuclear Physics, Novosibirsk 630090, Russia

Abstract

The project of the beamline "Diagnostics in the high-energy X-ray range" will become the basis for advanced scientific experiments in the materials science, geophysics, archaeologists, paleontology, biology and medicine. A number of research techniques will be implemented at the station using high-resolution microscopy, diffraction, and X-ray scattering. The energy photons in range from 30 to 150 KeV and the high brilliance of the SKIF source will allow using advanced methods of phase-contrast radiography to obtain high-contrast images with micrometer resolution.

XRD AND XRF IN THE HIGH-ENERGY X-RAY RANGE

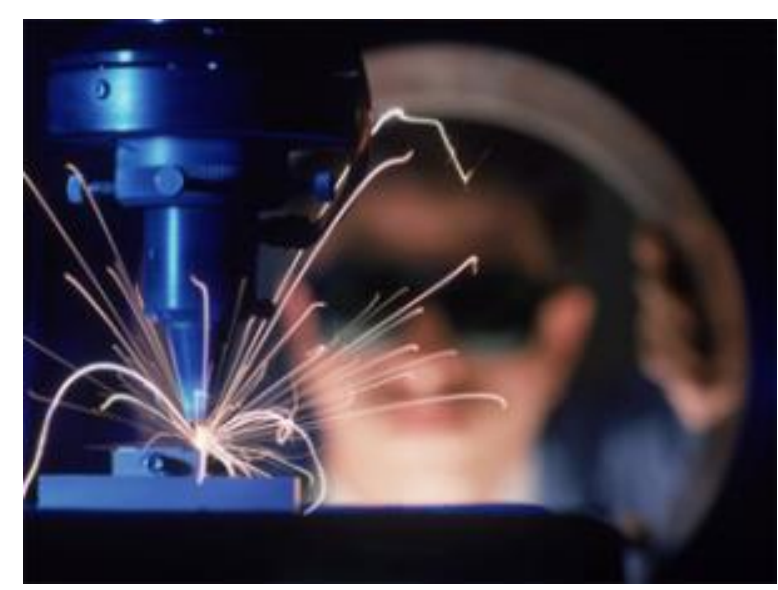

The basic tasks:

- The study of the synthesis of high temperature materials
- Analysis of the processes of melting and subsequent crystallization in metals
- XRF analysis for geoscience

XRD 1620 xN CS Flat Panel X-ray Detector
 Active area : 410 x 410 mm²
 Pixel size: 200 μm²
 FPS: 4
 Energy range: 20 keV– 15 MeV
 ADC: 16 bit

36 pixel germanium energy dispersive detector
 Active area : 30 x 30 mm²
 Pixel size: 5 mm.
 Detector thickness: from 10 mm
 Energy range: 5 – 200 keV
 Energy resolution: 130 eV – 250 eV

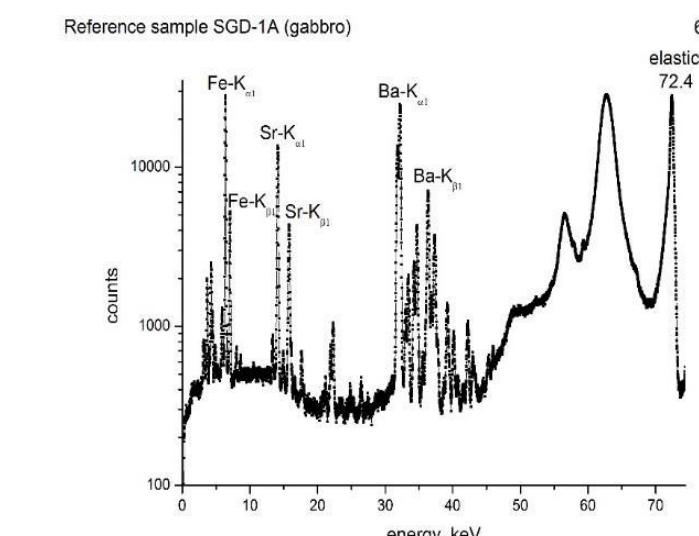

BEAMLINE «DIAGNOSTICS IN THE HIGH-ENERGY X-RAY RANGE»

As a source of high-energy radiation, it is planned to use a superconducting wiggler, which will provide a high radiation flux at the level of 10¹²-10¹³ photons in the energy photons range from 30 to 150 keV. It is planned to create three experimental end-station on the beamline, which will operate in sequential mode.

The end-station closest to the source will focus on research with using x-ray diffraction and x-ray spectroscopy methods in the high-energy range. The next end-station is intended for in situ investigation of large (up to 1 cm³) volumes of matter under extreme conditions using energy-dispersive diffraction and radiography methods. At the end of the channel, there will be an end-station that allows you to get high-contrast images in the x-ray range for a large number of scientific applications.

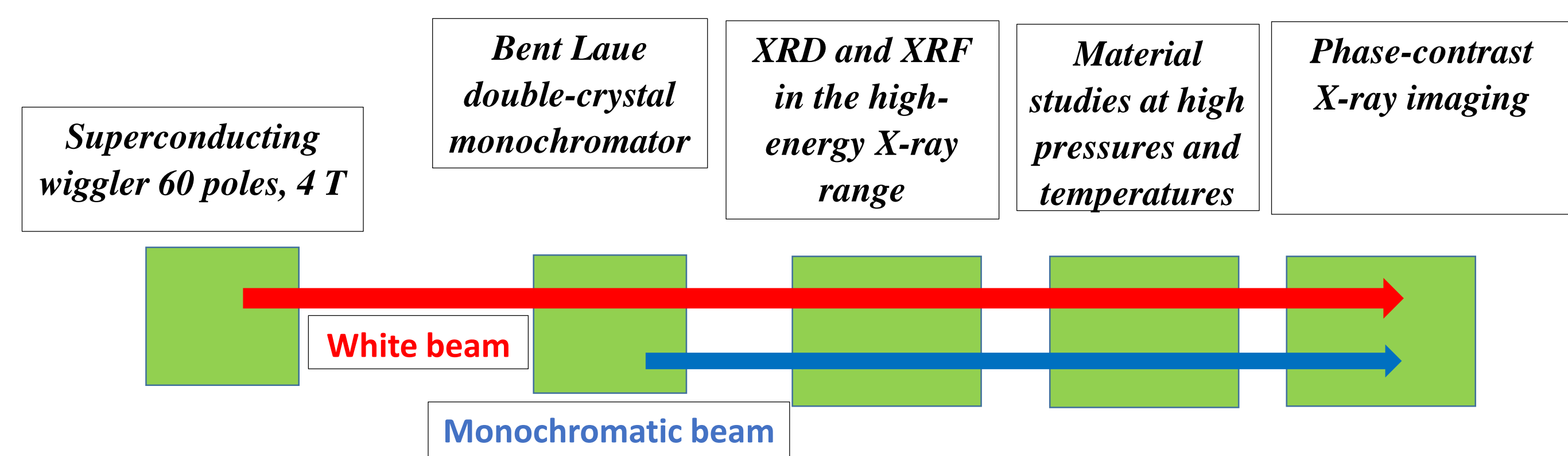

SR SPECTRUM OF SUPERCONDUCTING 60 POLES WIGGLER, 4 T

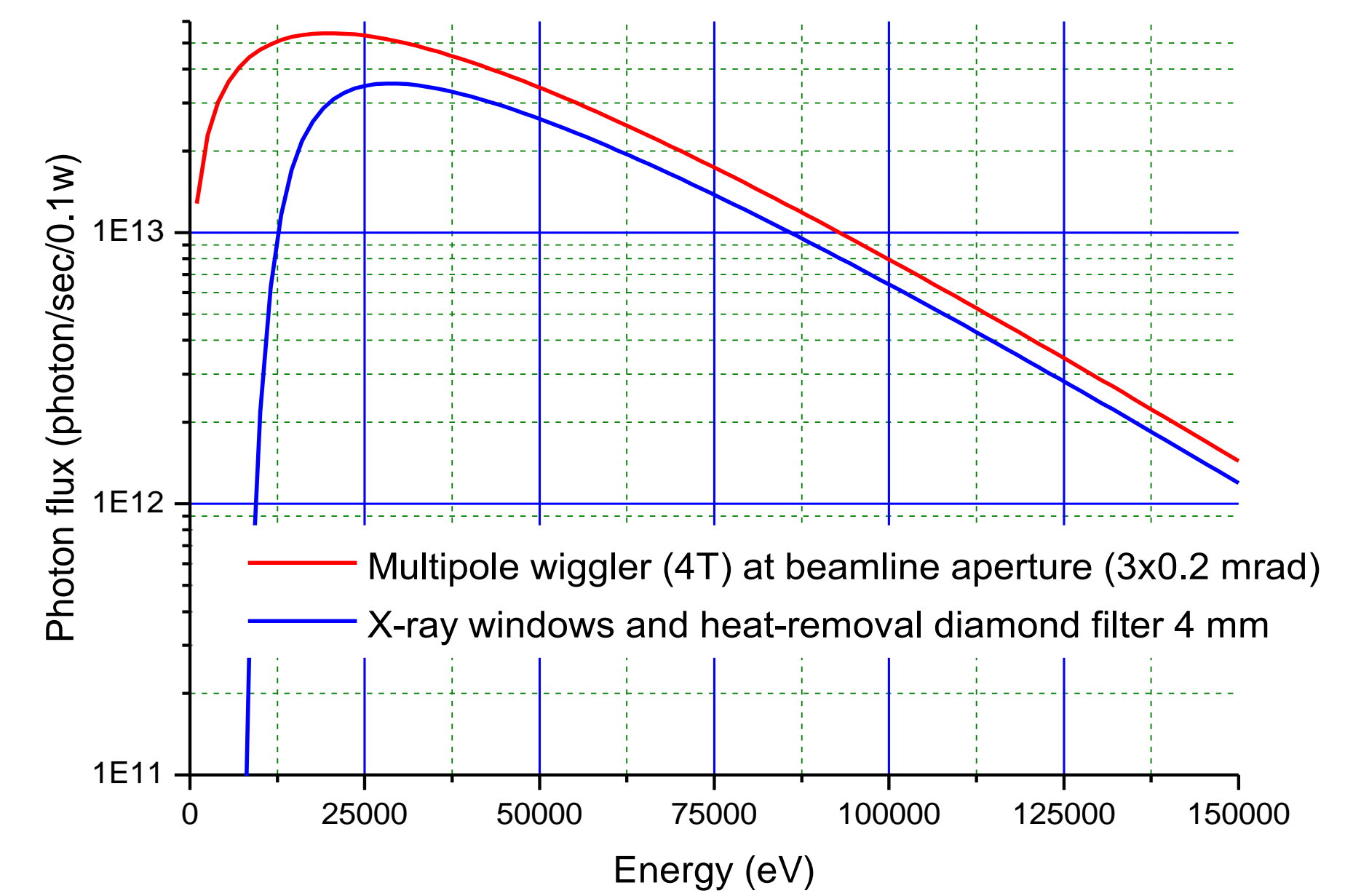

BENT LAUE DOUBLE-CRYSTAL MONOCHROMATOR FOR RANGE FROM 30 TO 150 KEV

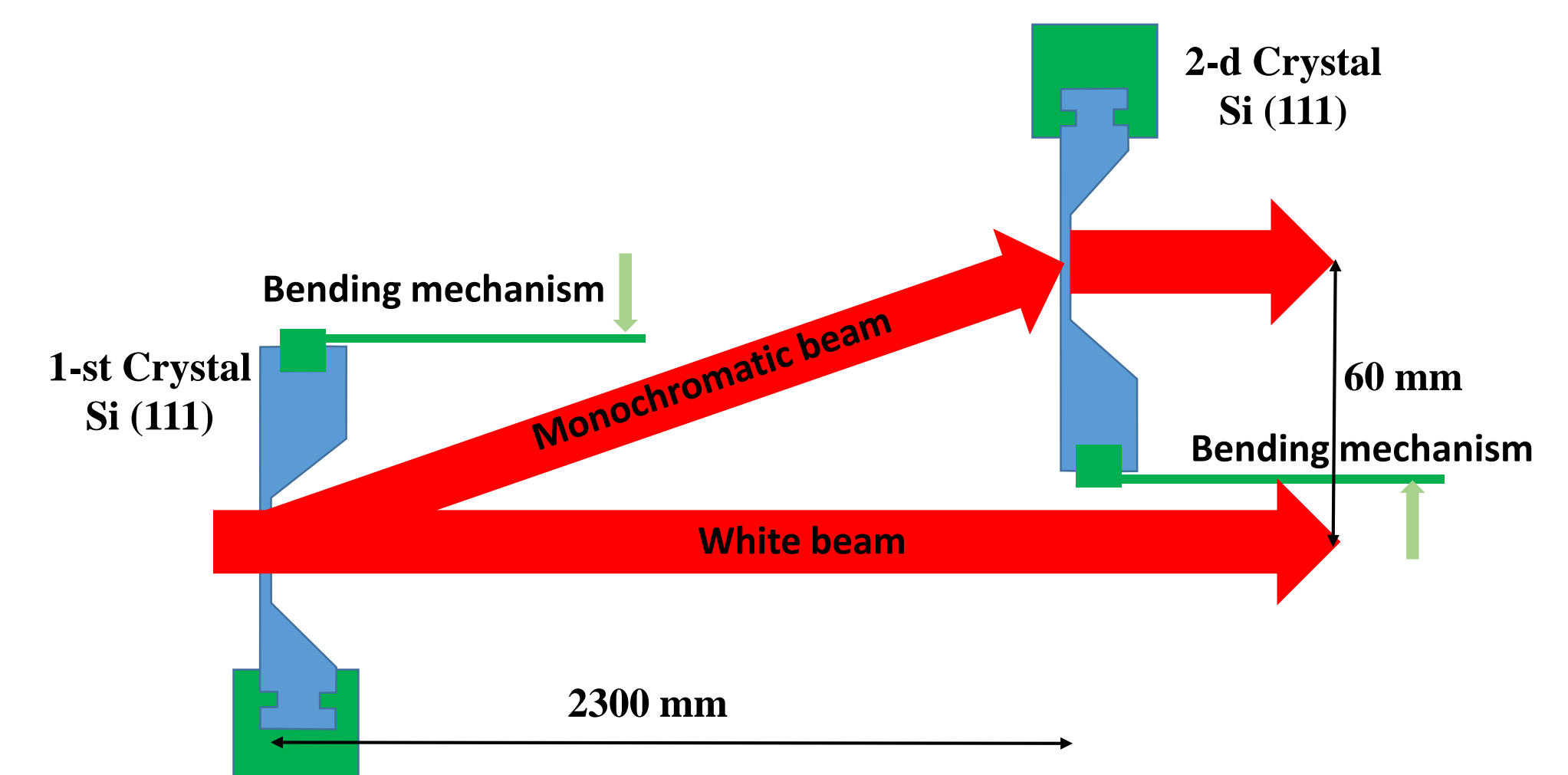

MATERIAL STUDIES AT HIGH PRESSURES AND TEMPERATURES

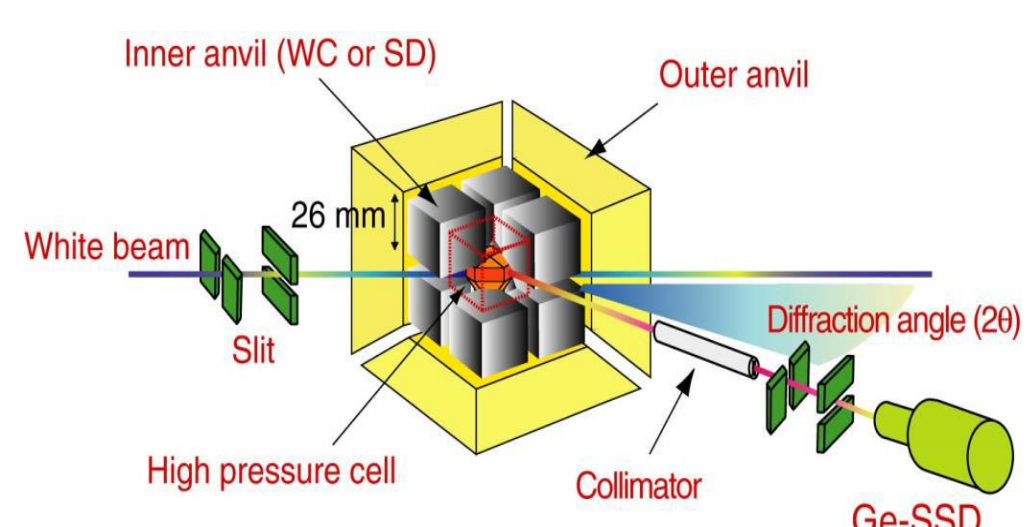

The basic tasks:

- Phase diagrams of crystalline substances (rocks, minerals) in the coordinates of pressure and temperature.
- P-V-T equations of state of crystalline phases
- Ultrasonic interferometry at high pressures and temperatures.
- Measurement of electrical conductivity at high pressures and temperatures.
- The study of the rheological properties of rocks at extreme pressures and temperatures.
- Studying the kinetics of phase transitions and solid-phase reactions.
- Characterization of functional materials at pressures ranging from 3 to 10 GPa and temperatures up to 2000°K

Multi-anvil press for generate 10GPa and 2000°K with high vertical angle aperture

1 m

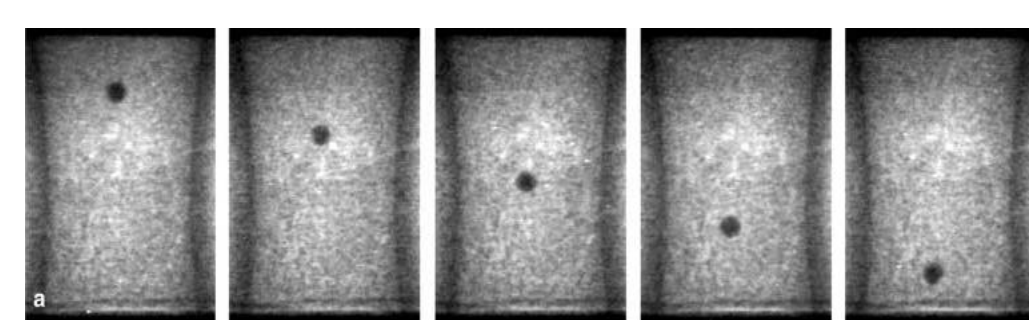
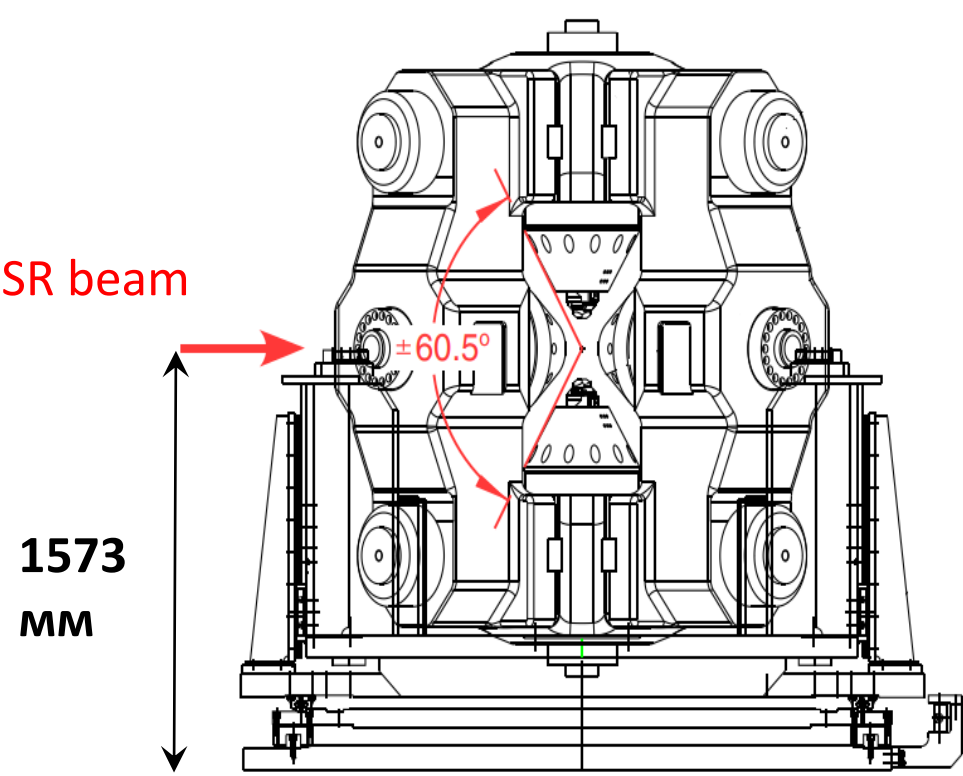

Kimberlite melt viscosity measurement by method sinking spheres at 6 GPa and 1200-1600 ° C



PHASE-CONTRAST X-RAY IMAGING

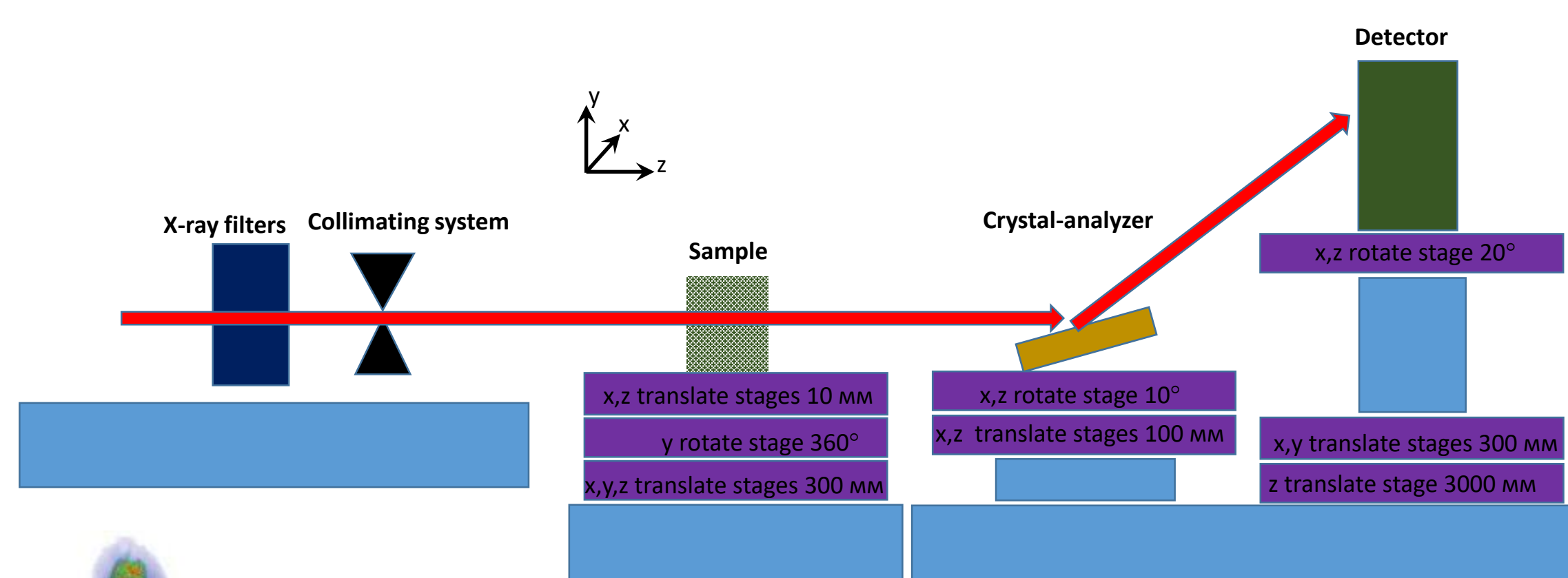

The basic tasks:

- X-ray imaging for biological, medical, archeology and paleontology application
- Development of the radiation therapy methods
- 3D inspection mechanical components after extreme mechanical and thermal loading
- Time resolve tomography for material and geology sciences

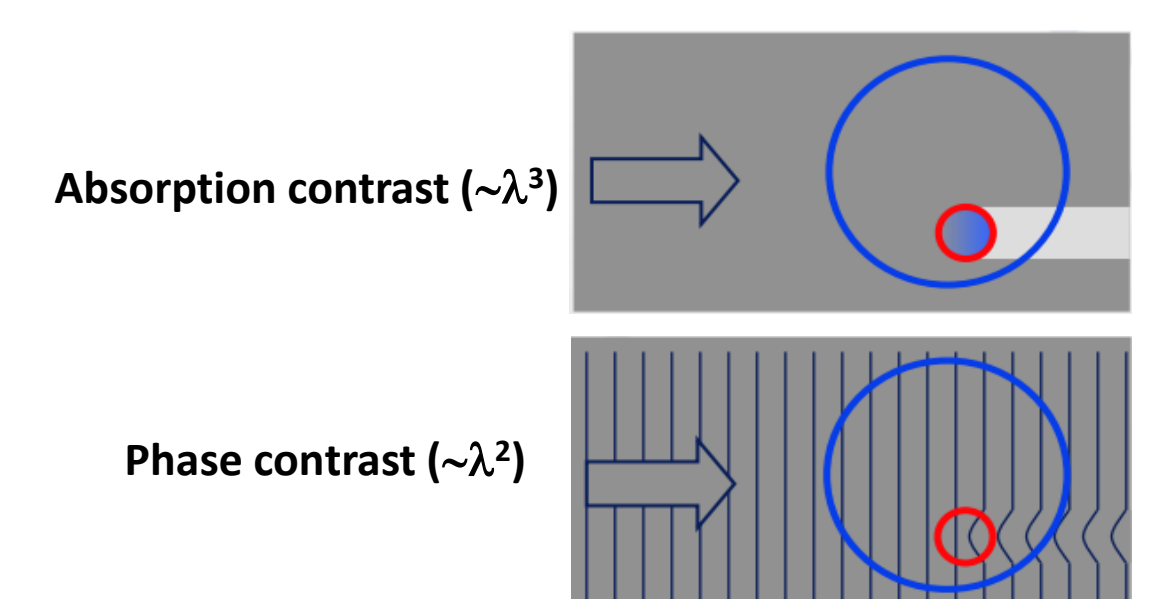

X-ray imaging for biological and medical application

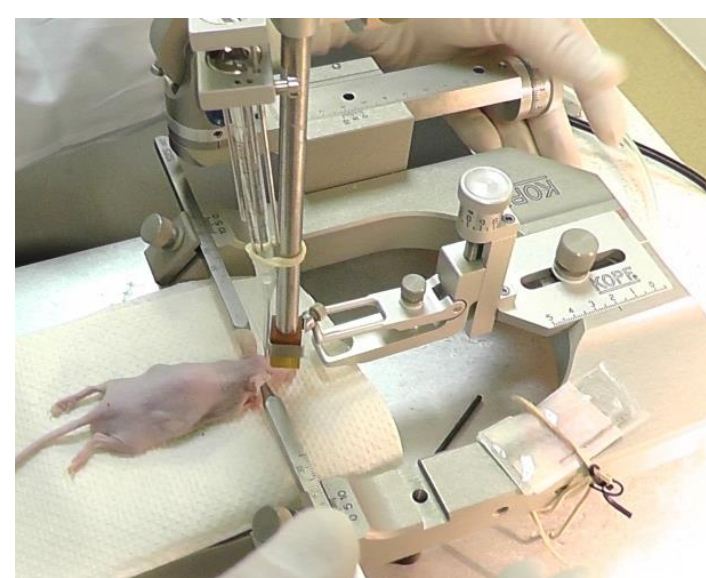

Microbeam radiation therapy

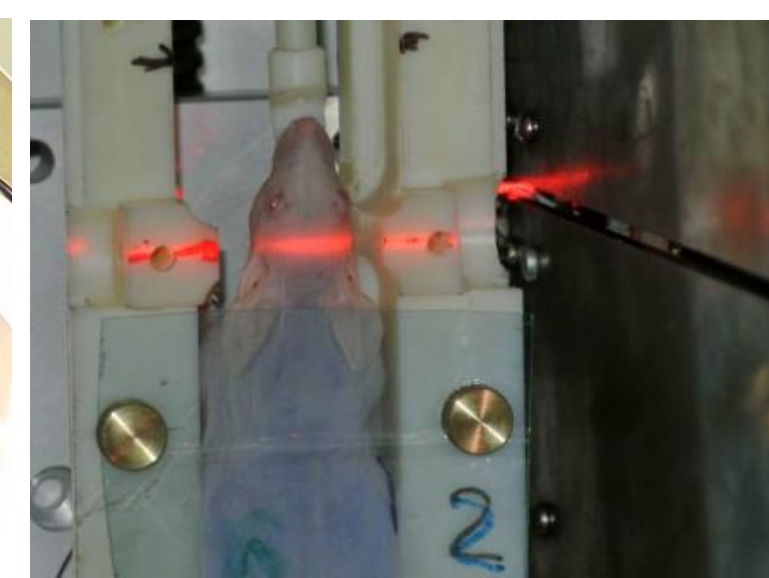

Investigation of archaeological paleontological items

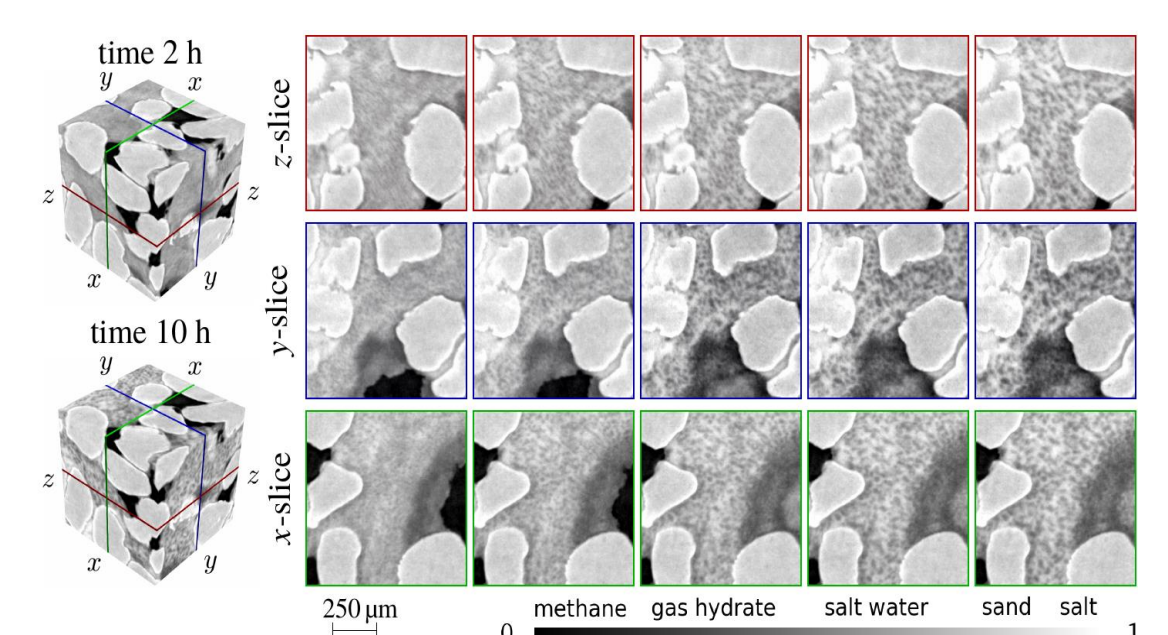
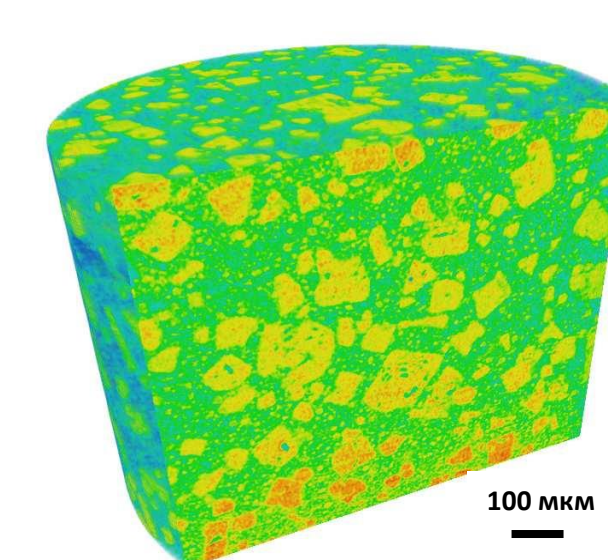
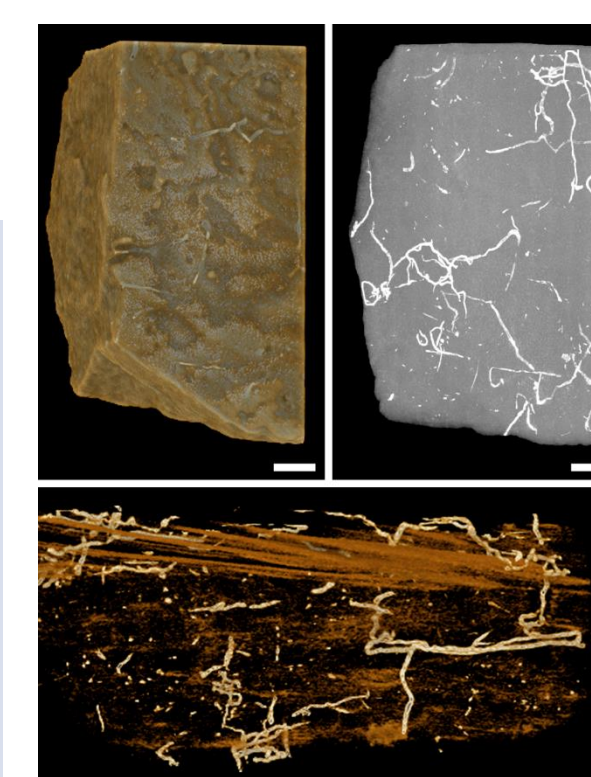
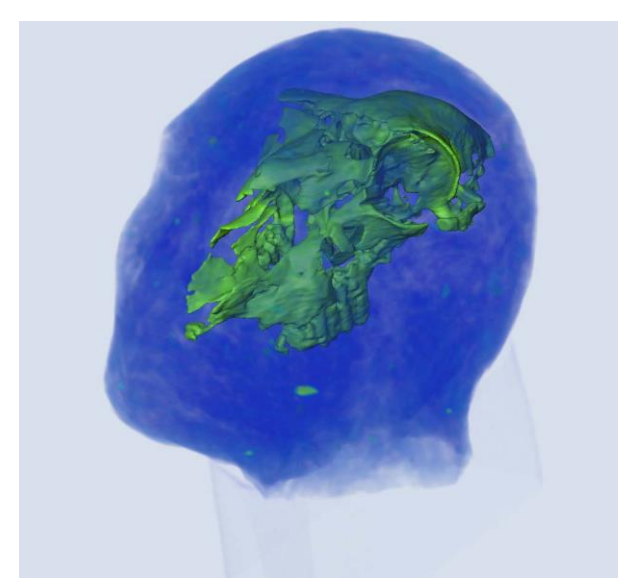

Dynamic in-situ imaging of methane hydrate formation and self-preservation in porous media

X-ray imaging for material and geology sciences